

SUNSHIELD

Retractable Awnings: **Installation Guide**

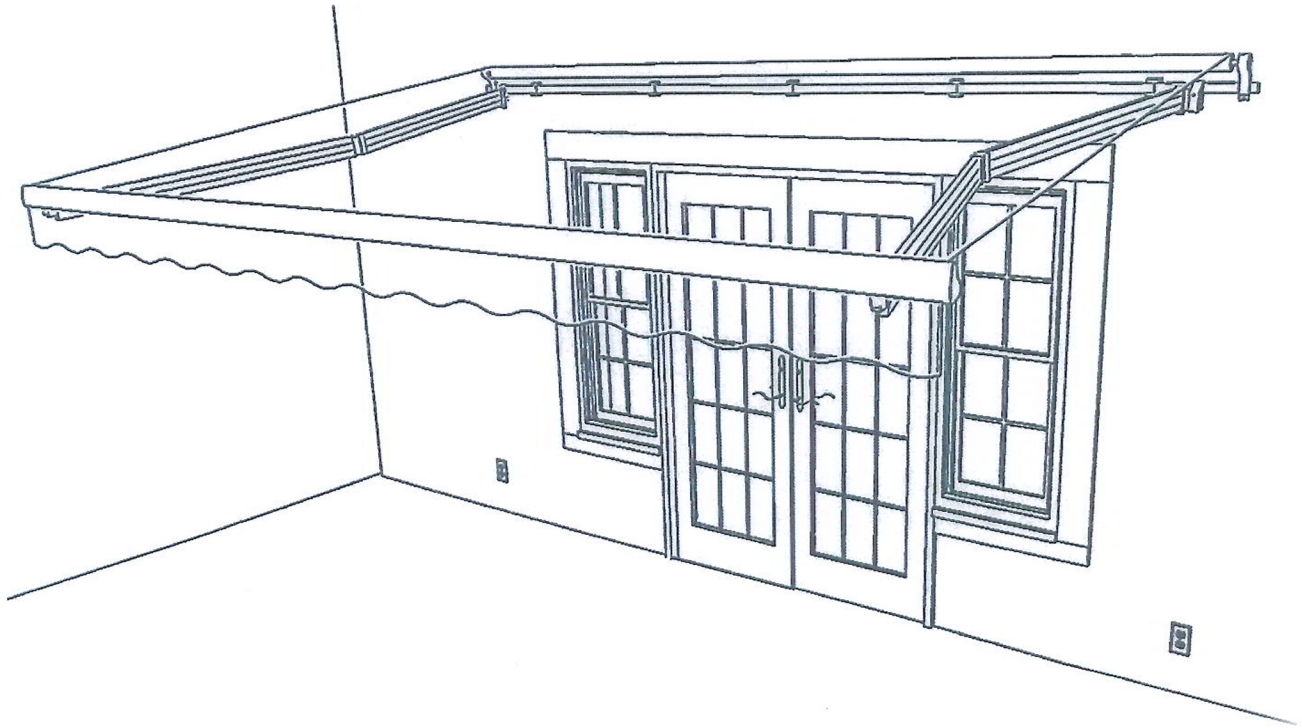

Manual Crank



Remote Operation



Easy to Clean

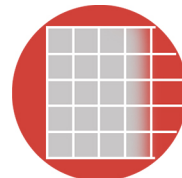

No-fade Fabric



Roll-away



Shading







UV Protection

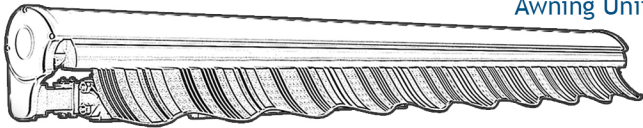
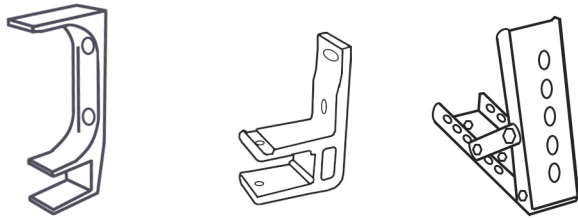
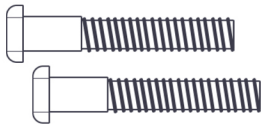
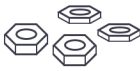

Wind Sensor

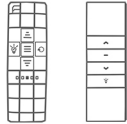
Package Contents

| Part | Quantity | |
|--|------------|------------|
|  <p>Awning Unit</p> | 1 | |
|  <p>Soffit Mount Wall Mount Roof Mount</p> | ≤16.4 Feet | ≤19.4 Feet |
|  <p>Retaining Hex Bolt</p> | 6 | 8 |
|  <p>Retaining Nuts Hex Bolts</p> | 6 | 8 |
|  <p>Manual Hand Crank</p> | 1 | |
|  <p>Instruction Manual</p> | 1 | |
|  <p>Remote Control *Your package will include one of two designs*</p> | 1 | |
|  <p>Limit Adjuster</p> | 1 | |

Your awning can include the following

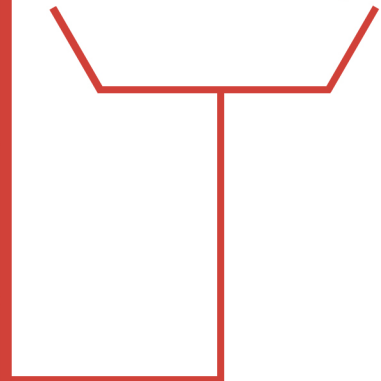

*Package contents may vary based on the chosen awning model and size.

Suggested Tools



Minimum
2 people
to install

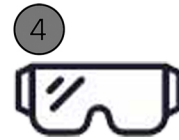
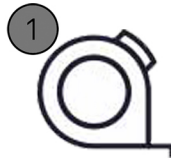

1 Tape Measure

2 Level

3 Stud Finder

4 Eye Protection

5 Chalk Line or
Laser Level

6 Sockets &
Ratchet Set

7 Phillips Head
Screwdriver

8 Rubber Mallet

9 Electric Drill &
1/8" Drill Bit

10 Caulk &
Caulking Gun

11 Allen Wrenches:
3mm, 4mm, 5mm

12 Open/Box Wrenches

13 Ladders: 2

14 Pencil/Marker

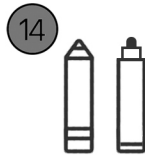
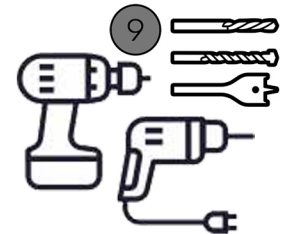
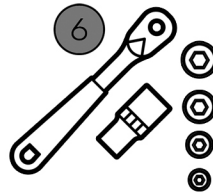

Awning Part Breakdown

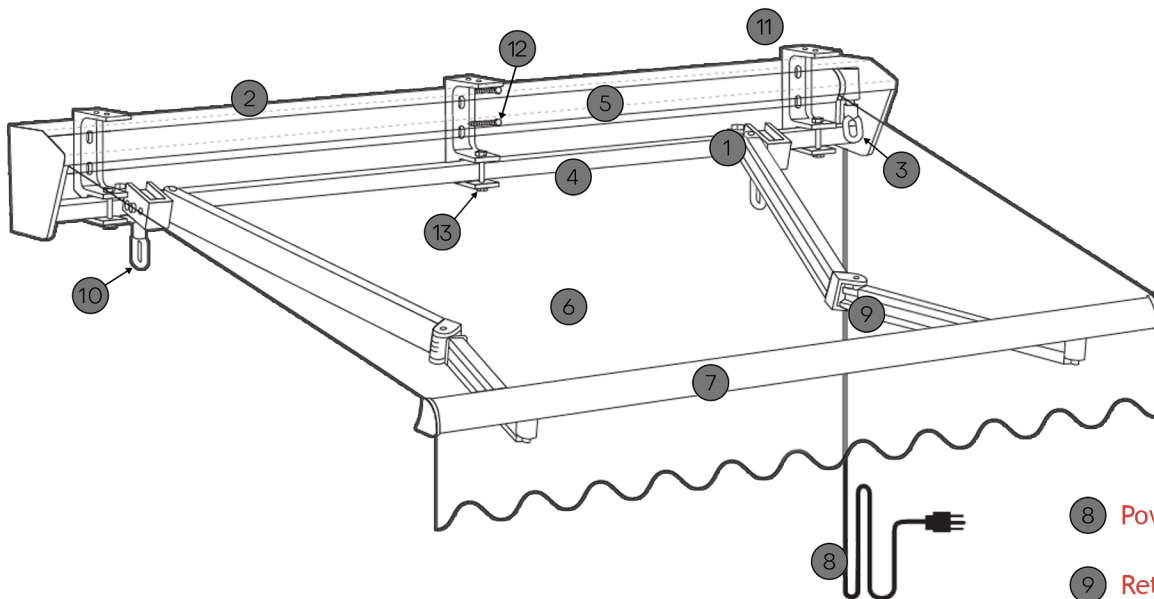

1 Arm Shoulder

2 Cassette

3 Motor Override Crank

4 Torsion Bar

5 Roller Tube

6 Awning Fabric

7 Front Bar

8 Power Cord

9 Retractable
Arms

10 Easy Crank
Adjustable
Pitch

11 Wall/Ceiling
Bracket

12 Wall Anchor

13 Retaining Bolt

INSTALLATION

Bracket Placement Reference Chart

Use the illustrations below for optimal bracket placement.

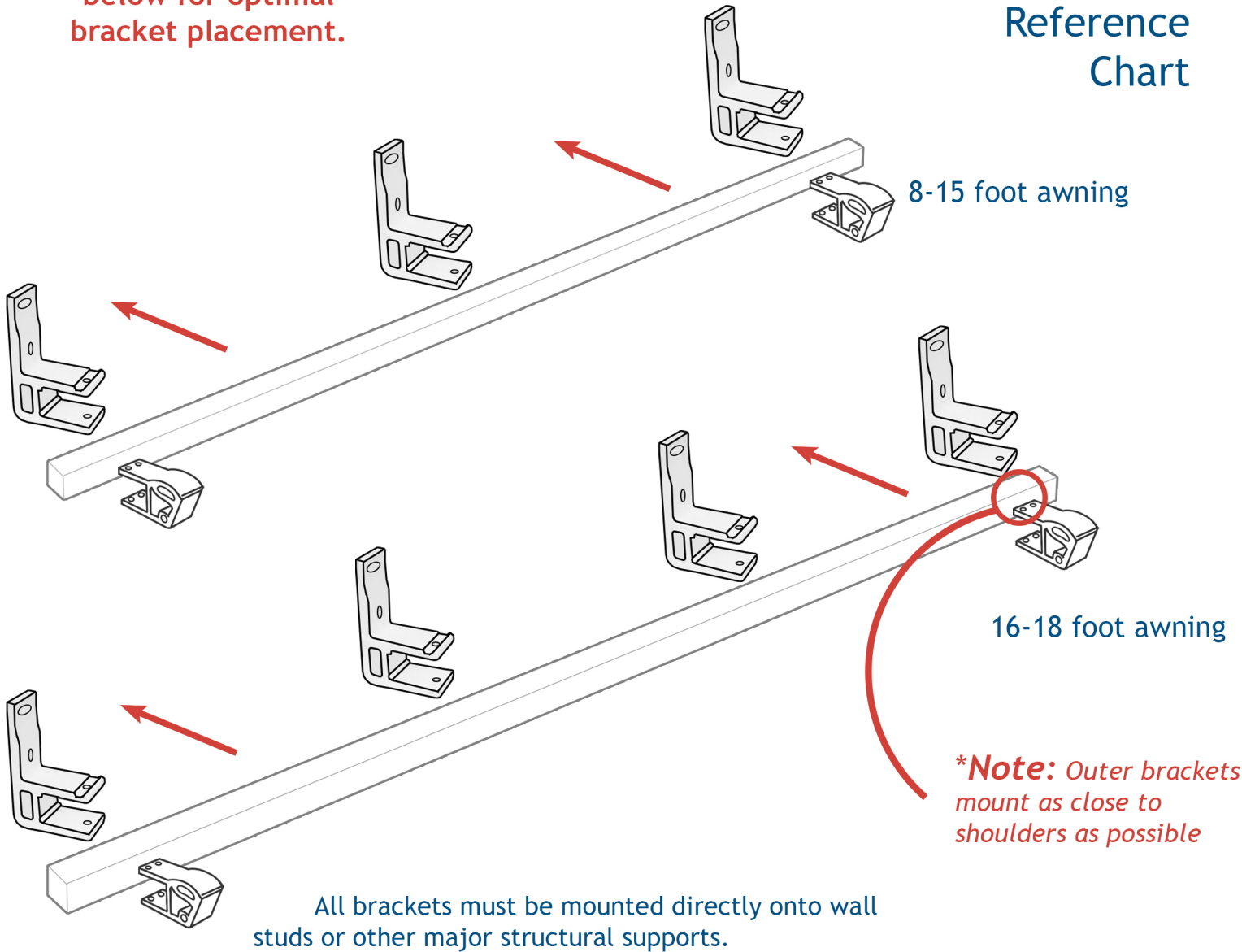

8-15 foot awning

16-18 foot awning

***Note:** Outer brackets mount as close to shoulders as possible

All brackets must be mounted directly onto wall studs or other major structural supports.

For optimal balance of the awning weight distribution, please attempt to follow the bracket placement as illustrated.

NOTE: Not every installation is identical and most studs/structural supports will not always align, the brackets may be moved to best safely fit your specific stud/structural support location while supporting the awning once installed.

INSTALLATION

Measurement

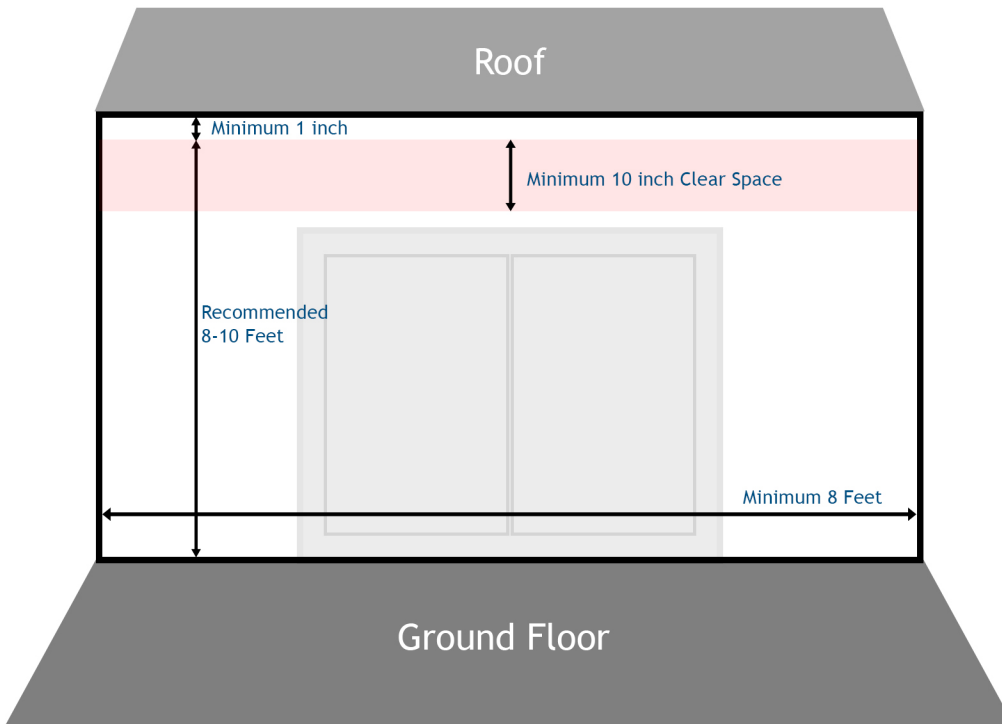

- **Unit Width** - The unit width is the overall width of the unit, end to end. The fabric will be 4 to 6 inches narrower than the overall width.
- **Projection** - The distance along the roofline that the unit will travel when fully extended.
- **Front Bar Height** - The distance from the ground to the bottom of the front bar. This measurement is typically set at 6 feet to 7 feet high.
- **Mounting Height** - The distance from the top of the installation bracket to the ground or surface.
- **Unit Clearance** - From the top of the install bracket to the bottom of the arm when retracted. You'll need a minimum of 8 inches of clearance. This includes any doors that open out, casement windows, vents, exterior mounted lights, etc.

Your Sunshield awning is already delivered with an optimally adjusted pitch angle. However, users can adjust the screen angle within a range of 5° - 45° as desired.

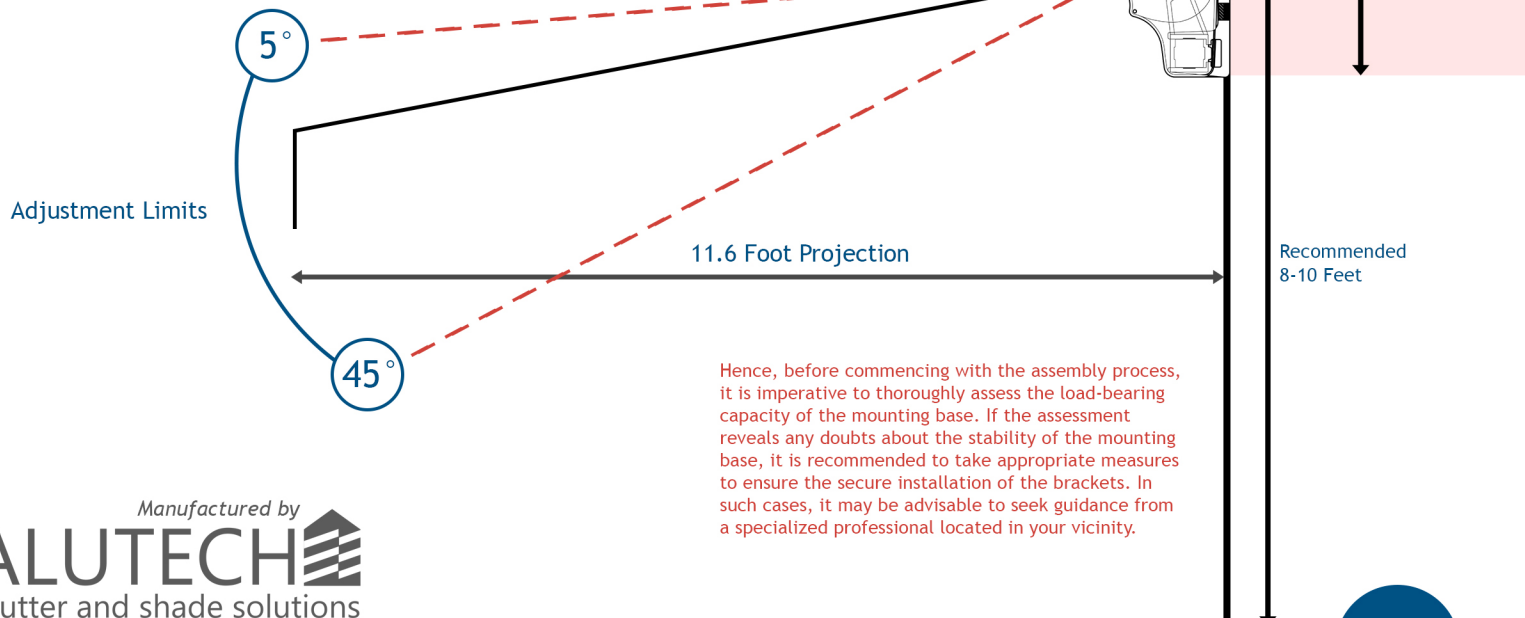

INSTALLATION

Additional Measurement & Bracket Placement

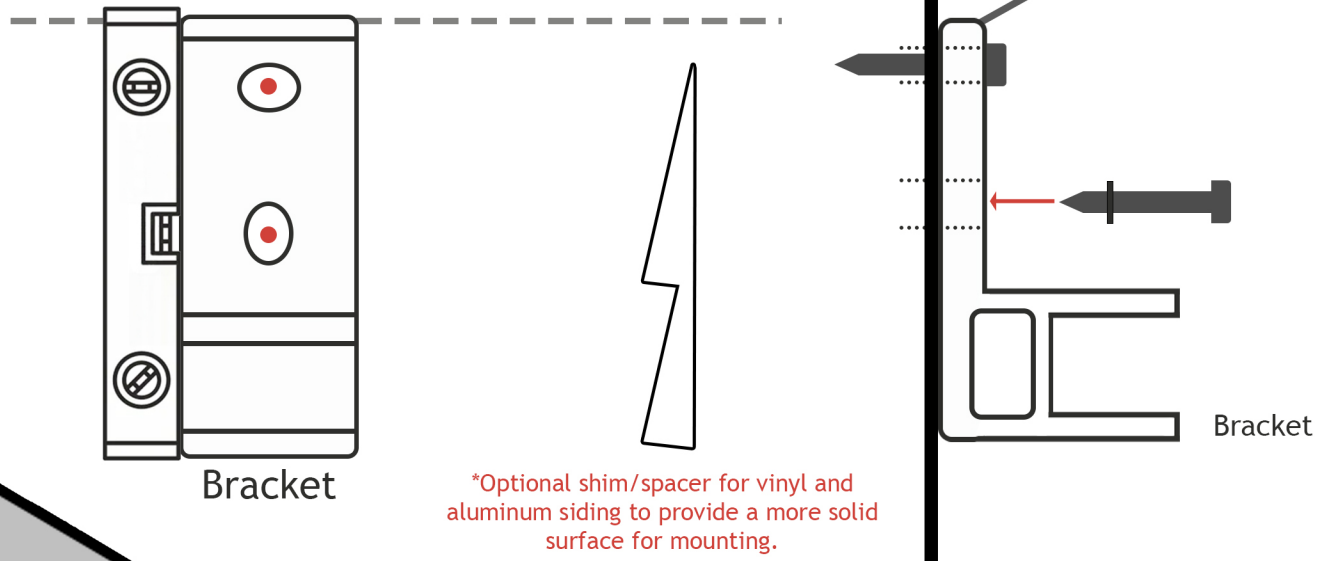

*Optional shim/spacer for vinyl and aluminum siding to provide a more solid surface for mounting.

Mark Drilling Holes

After choosing the mounting position, you can mark where you need to drill holes for the brackets. Draw a horizontal line at the height of the required place. Use a long tape measure and a level and chalk.

We already marked where and with what brackets need to be mounted. Measure the width between the brackets and copy it to the line on your wall/ceiling. Mark the corresponding places on the wall by running a marker pen through the holes at the bottom of the brackets.

Make sure the two outer brackets are located outside of the arm stands and one is located in the middle of the awning.

Drilling Holes

Use a 1/4" drill to drill the holes for the brackets at the appropriate marks on the wall. The holes should be 3" deep in the wall.

Insert Anchors into the Wall

After drilling the holes, you can insert the anchors into the wall. Remove the lock nut, washer and locking ring before you insert the anchor. Store these parts so you can easily retrieve them for the next step.

It may be necessary to drive the anchor bolts in with a wooden hammer because they do not go in easily. Do not use a metal hammer for this purpose because this could result in damage to the threads on the top of the bolt.

If the bolts need to be driven into the wall with a hammer, we recommend initially placing the nut on the screw loosely (only placing it loosely on the bolt) because this avoids damage to the bolt threads.

Fixing the Brackets

Place the bracket on the screw protruding from the wall. Then, add locking ring and washer and fix the bracket with lock nuts. Tighten them well.

Firmly tighten bolts with a wrench - it is best to use a wrench with a closed end rather than an open end because this will avoid damage to the nut if it should slip. As soon as they are fully inserted, the brackets must sit firmly in the wall. If they are still moving in any way, you must further tighten it. Ensure that the wall brackets are screwed firmly to the wall so that they can in

Manufactured by

ALUTECH
shutter and shade solutions

INSTALLATION

Awning Placement

- Begin by carefully removing the retaining bolts from each bracket.
- Lift and slide the awning into position, ensuring a precise alignment with the brackets. Then, gently slide the torsion bar into the bracket fork.
- Insert the retaining bolt and washer into the designated bracket fork holes, taking care to position them accurately. Once in place, secure the assembly with the corresponding nut.
- To ensure structural integrity, firmly tighten the bolts using an appropriate socket wrench.

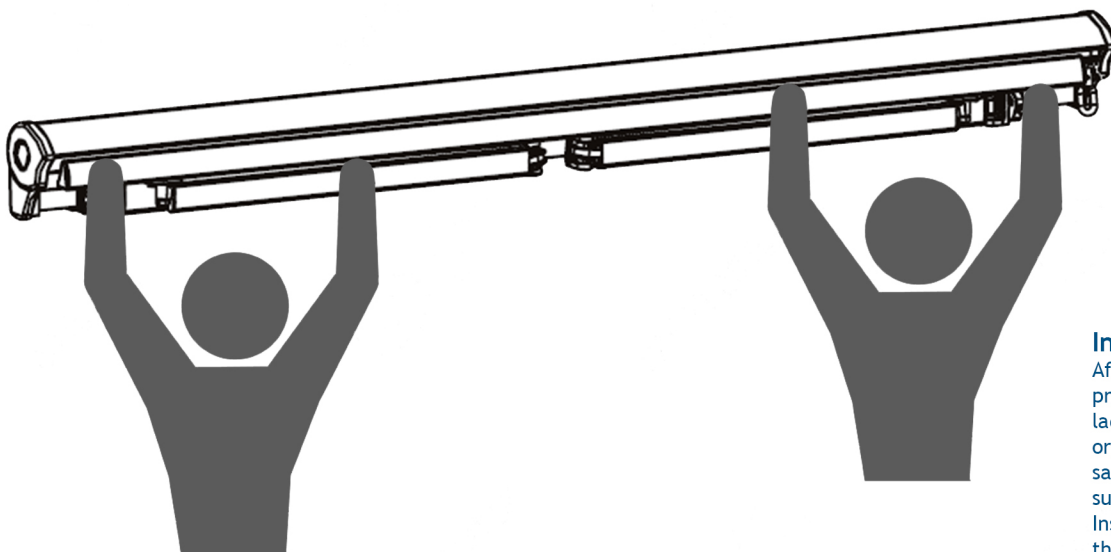
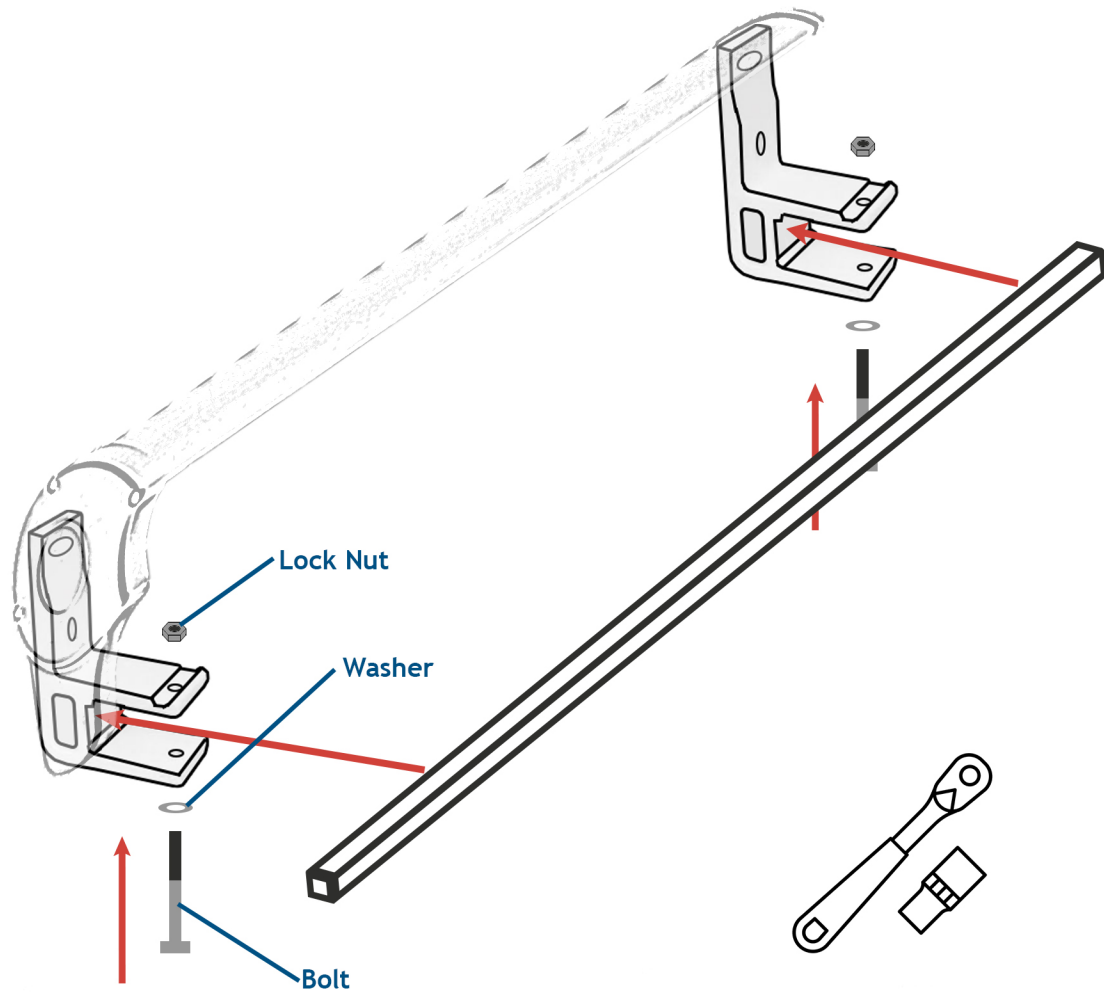

**Minimum 2
people to
install**

Install Awning

After all brackets have been mounted properly, you can fix the awning. Ensure all ladders are firmly resting on the ground in order to prevent accidents or injury. For your safety, ensure to only use ladders that are suitable for such assembly work.

Insert the awning into brackets. Then insert the safety screw and fix it with lock nut.

INSTALLATION

Operation

Extend and Retract the Awning





The awning can be extended and retracted by a crank handle included in delivery or remote control. Insert the handle in the loop that is fixed on the awning. Open and close the awning by turning the handle.

The awning can be extended and retracted by a remote control included in delivery.

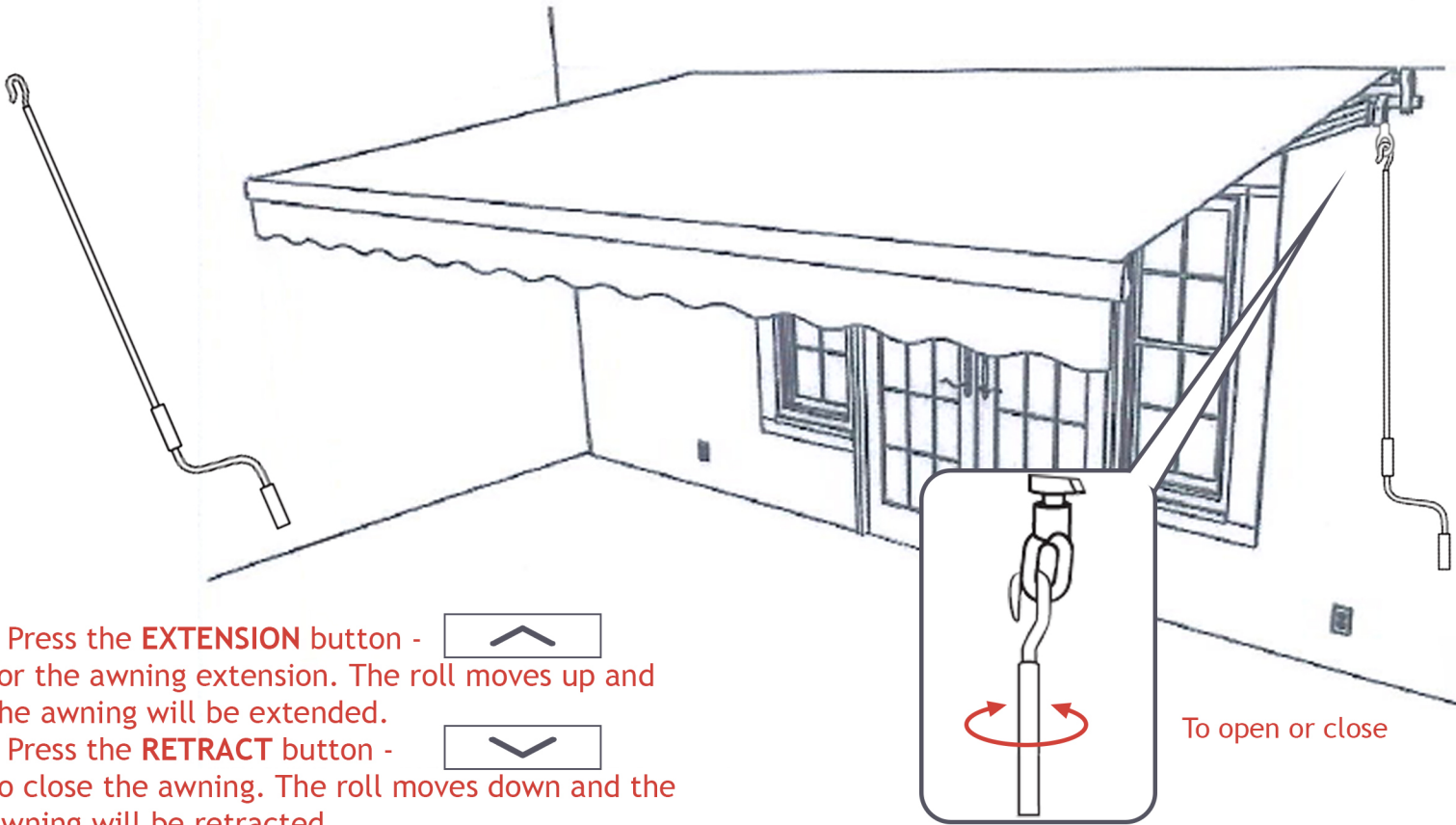
- Do not put any objects or parts of your body in the awning while extending and retracting. This could result in serious injury.
- When the front bar touches the roller during retraction, don't try to make them closer, otherwise the product might become damaged.
- Take out the crank handle from the loop after adjusting the awning to your desired position and place in a safe place that's unreachable by children.

- The awning's crank gear has no stop limit revolutions of the roller tube. To avoid damage to the fabric, therefore the awning fabric must always be properly rolled up.
- The awnings are intended as a protection against the sun only. It is not to be used during periods of strong wind, rain, hail, or snow. In case of such conditions, retract the awning immediately.
- Never allow children to play with the awning.
- Be sure the fabric is tensioned. If the fabric is not tensioned during extension, please turn counter-clockwise until the fabric is tensioned.



- Press the **EXTENSION** button -  for the awning extension. The roll moves up and the awning will be extended.
- Press the **RETRACT** button -  to close the awning. The roll moves down and the awning will be retracted.
- Press the **STOP** button -  to stop the extension/retraction of the awning.
- Press the **LIGHT** button -  to turn on/off the awning lights

To open or close

***NOTE:** Please follow user manual for proper procedure when adjusting your awnings pitch.

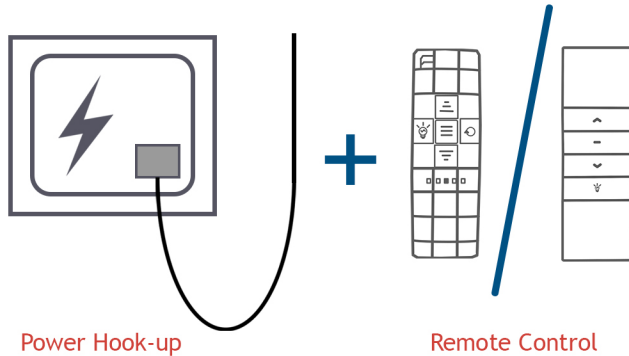

Power Hook-up

Remote Control

The awning can be extended and retracted by a remote control included in delivery

Manufactured by
ALUTECH
shutter and shade solutions

INSTALLATION

Fabric Rolling Direction

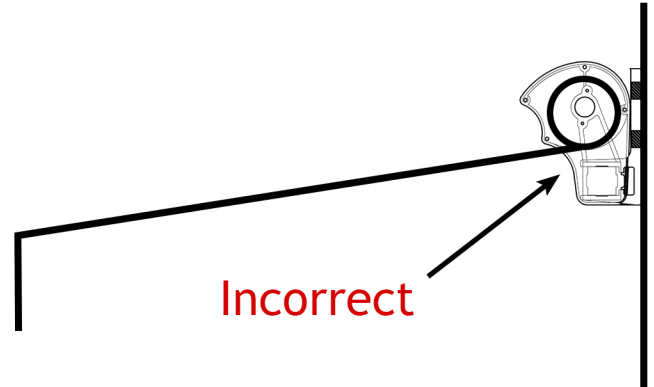
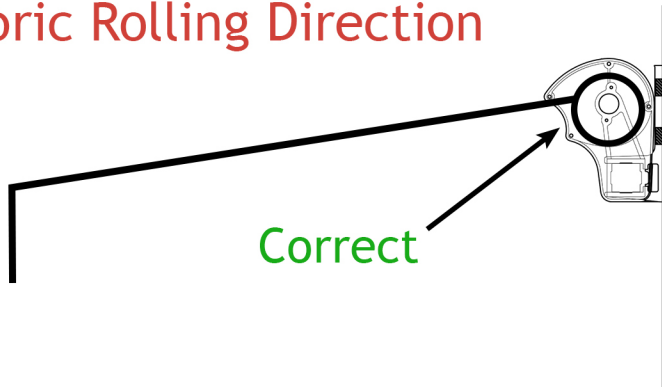

Pitch Adjustment

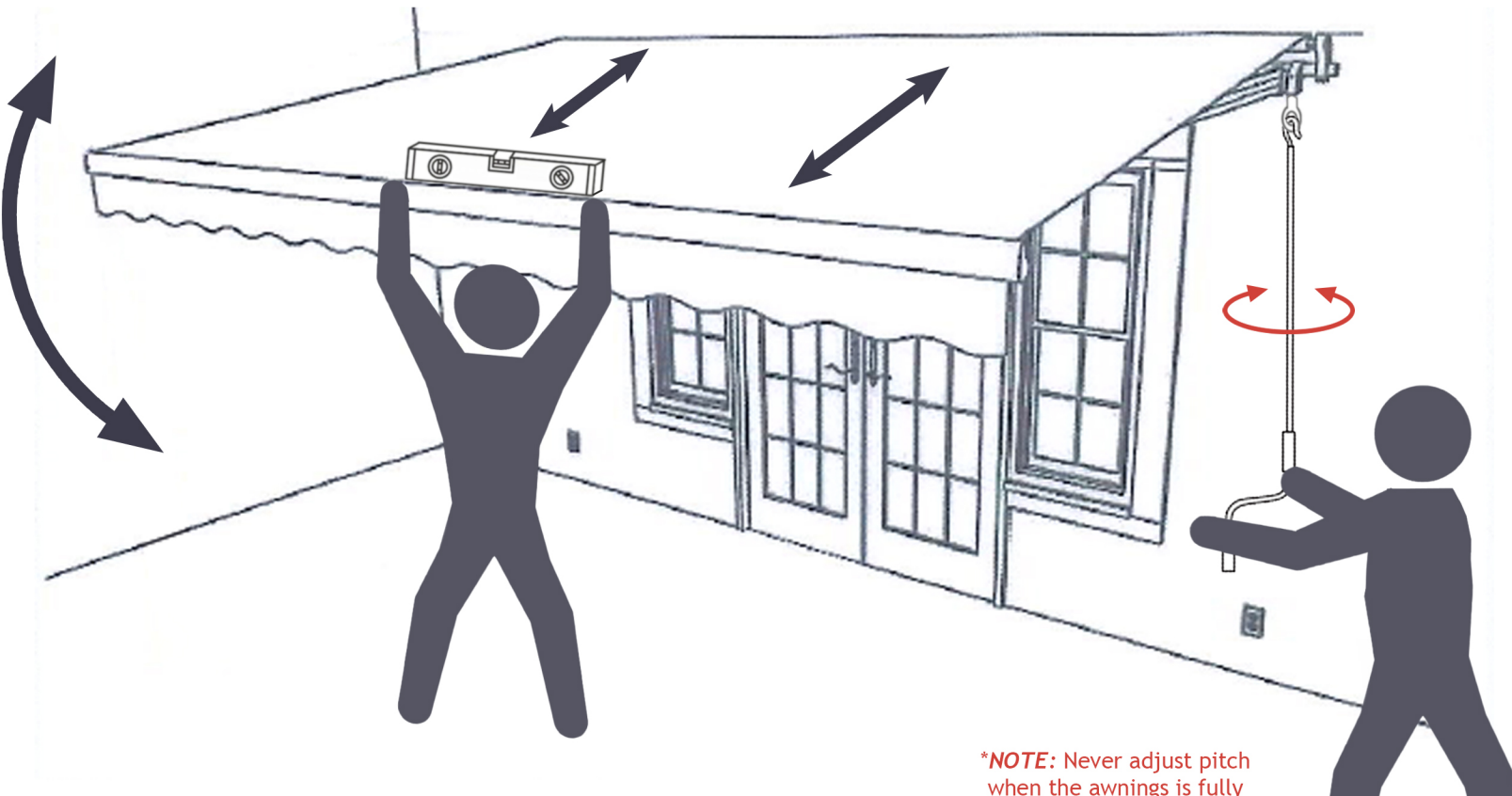

Use a level tool to ensure the awning is level for optimal water runoff and promote structural stability.

***NOTE:** Never adjust pitch when the awnings is fully extended. Damage could occur! See owners Manual for more details.

***Never allow children to play with the awning.**

ADDITIONAL INFO

General Warnings

In order to prevent damage to your awning unit, don't leave your awning out during harsh weather conditions such as heavy rain, strong winds, or snowstorms. Damage to the fabric, frame, or motor may void your warranty.

If your awning doesn't operate properly, do not force it open or closed. This could result in further damaging the awning and its components.

To clean your awning, use a soft brush and mild soap/water solution to gently clean the fabric. Avoid using harsh chemicals or abrasive materials. This could cause the fabric to deteriorate, lose its color, or become brittle.

Frame Care

To ensure the optimal maintenance of awning frames, it is recommended to undertake regular upkeep. This involves an annual cleaning regimen, utilizing a mixture of fresh water and a mild soap solution. Neglecting this routine may result in the accumulation of sand, dirt, and salt deposits, which can impede the functionality of the awning components.

Additionally, for the seamless operation of your awning, it is imperative to lubricate all articulating joints and cables with a clear, dry silicone spray. This will contribute to sustaining peak performance in the awning's motion. Simultaneously, it is advisable to conduct periodic inspections of caulked areas for potential cracks that may develop over time. Addressing any such issues is integral, ideally in conjunction with each exterior painting cycle of your residence, or at intervals no longer than two years.

Should you prefer not to undertake the washing and lubrication of your awning yourself, we recommend contacting the local dealer responsible for the installation of your product to explore the possibility of a service agreement. This will ensure the ongoing functionality and longevity of your awning system.

NOTICE: Improper placement and incorrect installation of the awning may pose significant safety hazards.

We strongly advise that you personally undertake the mounting process only once you have a comprehensive grasp of the installation instructions and have confirmed the suitability of the chosen wall or ceiling for awning installation. To ensure your safety, as well as that of others, we recommend enlisting the services of an authorized professional installer.

ADDITIONAL INFO

10 Year Limited Warranty

Warranty Entitlement

This Warranty applies only to the original purchaser who paid for the product and may not be assigned or transferred to subsequent owners.

Motors & Electronics

Alutech United, Inc. carries a 10-year warranty on all internal and electronic components included with the Sunshield awning, as long as proper use and voltage are maintained within accordance with motor and controls parameters.

Awning Accessories

Alutech United, Inc. carries a 2-year warranty on all accessories included with the awning. [Defined as accessories attached to the awning]

Frame

Alutech United, Inc. carries a 10-year warranty on all awning framing, components, and supports from failure due to defects in workmanship.

Paint Finish

Alutech United, Inc. carries a 3-year warranty on all painted framing extrusions. Excluded from this standard warranty are installations located within 2640 feet of the seaside. Those painted finishes will be covered with a 1-year warranty period.

Fabric

Alutech United, Inc. carries a 10-year warranty against becoming unusable due to excessive loss of color or strength, under proper use, and provided that the awning is not subjected to excessive winds or water pooling on the fabric.

Installation

Alutech United, Inc. only carries a 1-year warranty for products installed and or contracted through us directly. All other installations conducted through dealers or contractors are excluded from this warranty period.

General Info

Alutech United, Inc. is not liable for any injury, loss, or damage, whether direct and/or unintended, arising out of the improper use of, or the inability to operate products made by Alutech. This warranty also does not cover loss or damage resulting from improper assembly, improper installation, lack of care, and/or damage sustained by a natural disaster or any of "Acts of God."



The articles replaced according to the terms of this warranty shall be retained by Alutech United, Inc. It is the customer's responsibility to handle any freight cost associated with the repair or replacement. All costs related to the installation of the addicted Alutech United, Inc. product covered by this replacement warranty will not be the responsibility of Alutech United, Inc.

The preceding warranty is exclusive and instead of all other warranties of quality, whether written, oral, or implied.

ALUTECH



shutter and shade solutions

Selbyville, Delaware

-  302.436.6005
-  302.436.5100
-  1.800.233.1144



Sarasota, Florida

-  941.355.0970
-  941.355.0972
-  1.800.233.1144



SUNSHIELD



www.alutech.com

@AlutechUnited



ALUTECH
shutter and shade solutions

Alutech United, Inc. Shutter Solution - Any Shape, Any size, Any time
117 Dixon Street, DE 19975 - Phone 302-436-6005, Fax: 302-436-5100, Toll free: 1-800-233-1144
6620 19th Street #103., Sarasota, FL 34243 - Phone: 941-355-0970, Fax: 941-355-0972 - Online: www.alutech.com